

DC-DC Converter UNIT

PU Series (1W UNREGULATED DC-DC CONVERTER)

FEATURES

- 1000VDC-3000VDC ISOLATION
- EFFICIENCY UP TO 83%
- INTERNAL SMD TECHNOLOGY
- LOW COST
- NO HEATSINK REQUIRED
- 1W UNREGULATED OUTPUT POWER
- SINGLE IN LINE PACKAGE
- 100% BURNED IN
- MTBF > 2,000,000 HOURS

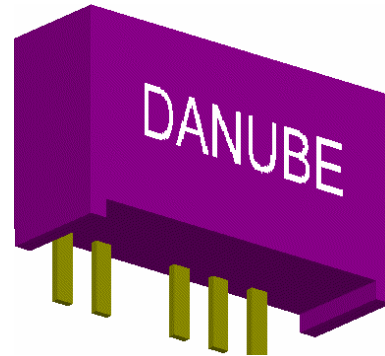

● OUTPUT SPECIFICATIONS

Voltage Setpoint Accuracy	+/-2% max
Temperature Coefficient	+/-0.03%/ °C
Ripple & Noise (20MHz BW)	100mVp-p max
Line Regulation ¹	+/-1.2% max
Load Regulation ²	+/-8% max
Short Circuit Protection	Momentary

● ENVIRONMENTAL SPECIFICATIONS

Operating Temperature	-25 °C to +71 °C
Storage Temperature	-55 °C to +125 °C
Cooling	Free-Air Convection

ALL SPECIFICATIONS TYPICAL AT NOMINAL LINE, FULL LOAD , AND 25 °C UNLESS OTHERWISE NOTED.

● INPUT SPECIFICATIONS

Input Voltage Range	+/-10% max
Input Filter	Capacitor Type

● GENERAL SPECIFICATIONS

Efficiency	70%-83%
Isolation Voltage ³	1000-3000 VDC min
Isolation Resistance	10 ⁹ ohms min
Switching Frequency	100 KHz min
Isolation Capacitance	80pF max
MTBF	2,000,000 Hours
Weight	2.1g Typ
Case Material	Non-Conductive Plastic
Case Size	19.6mm*6.1mm*10.2mm 19.6mm*7.1mm*10.2mm

¹ Line Regulation is for a 1.0% change in input Voltage.

² Load Regulation is for output load current change from 20% to 100%.

³ For 10 seconds

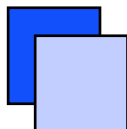

DC-DC Converter UNIT

PU Series (1W UNREGULATED DC-DC CONVERTER)

● SELECTION GUIDE (1) 1W 1000VDC ISOLATION

MODEL NUMBER	INPUT VOLTAGE (VDC)	OUTPUT VOLTAGE (VDC)	OUTPUT CURRENT (mA)	INPUT CURRENT(mA)		EFF (%)	ISOLATION (VDC)	PACKAGE
				FULL LOAD	NO LOAD			
				PUS-0505(A or B or E)	5			
PUS-0509(A or B or E)	5	9	111	257	25	78	1000	A or B or E
PUS-0512(A or B or E)	5	12	84	253	26	79	1000	A or B or E
PUS-0515(A or B or E)	5	15	67	253	28	79	1000	A or B or E
PUD-0505(A or B or E)	5	+/-5	+/-100	274	21	73	1000	A or B or E
PUD-0512(A or B or E)	5	+/-12	+/-42	253	28	79	1000	A or B or E
PUD-0515(A or B or E)	5	+/-15	+/-34	253	28	79	1000	A or B or E
PUS-1205(A or B or E)	12	5	200	112	11	74	1000	A or B or E
PUS-1212(A or B or E)	12	12	84	102	10	82	1000	A or B or E
PUS-1215(A or B or E)	12	15	67	102	12	82	1000	A or B or E
PUD-1205(A or B or E)	12	+/-5	+/-100	112	11	74	1000	A or B or E
PUD-1212(A or B or E)	12	+/-12	+/-42	105	13	79	1000	A or B or E
PUD-1215(A or B or E)	12	+/-15	+/-34	101	10	83	1000	A or B or E
PUS-2405C	24	5	200	57	9	73	1000	C
PUS-2412C	24	12	84	54	8	77	1000	C
PUS-2415C	24	15	67	52	7	80	1000	C
PUD-2405C	24	+/-5	+/-100	57	9	73	1000	C
PUD-2412C	24	+/-12	+/-42	54	8	77	1000	C
PUD-2415C	24	+/-15	+/-34	52	7	80	1000	C

Note: Other input to output voltages may be available. Please contact factory.

ORDERING INFORMATION:

FOR EXAMPLE: PUS-****A(SINGLE OUTPUT A PACKAGE)
PUD-****A(DUAL OUTPUT A PACKAGE)
PUS-****B(SINGLE OUTPUT B PACKAGE)
PUD-****B(DUAL OUTPUT B PACKAGE)

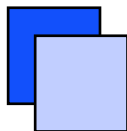

DC-DC Converter UNIT

PU Series (1W UNREGULATED DC-DC CONVERTER)

● SELECTION GUIDE (2) 1W 3000VDC ISOLATION

MODEL NUMBER	INPUT VOLTAGE (VDC)	OUTPUT VOLTAGE (VDC)	OUTPUT CURRENT (mA)	INPUT CURRENT(mA)		EFF (%)	ISOLATION (VDC)	PACKAGE
				FULL LOAD	NO LOAD			
				PUS-0505-3K	5			
PUS-0512-3K	5	12	84	255	28	78	3000	B
PUS-0515-3K	5	15	67	253	28	79	3000	B
PUD-0505-3K	5	+/-5	+/-100	274	21	73	3000	B
PUD-0512-3K	5	+/-12	+/-42	253	28	79	3000	B
PUD-0515-3K	5	+/-15	+/-34	253	28	79	3000	B
PUS-1205-3K	12	5	200	112	11	74	3000	B
PUS-1212-3K	12	12	84	102	10	82	3000	B
PUS-1215-3K	12	15	67	100	11	83	3000	B
PUD-1205-3K	12	+/-5	+/-100	112	11	74	3000	B
PUD-1212-3K	12	+/-12	+/-42	101	10	83	3000	B
PUD-1215-3K	12	+/-15	+/-34	101	10	83	3000	B
PUS-2405-3K	24	5	200	57	9	73	3000	D
PUS-2412-3K	24	12	84	54	8	77	3000	D
PUS-2415-3K	24	15	67	52	7	80	3000	D
PUD-2405-3K	24	+/-5	+/-100	57	9	73	3000	D
PUD-2412-3K	24	+/-12	+/-42	54	8	77	3000	D
PUD-2415-3K	24	+/-15	+/-34	52	7	80	3000	D

Note: Other input to output voltages may be available. Please contact factory.

ORDERING INFORMATION:

FOR EXAMPLE: PUS-****-3K(SINGLE OUTPUT 3000V ISOLATION)
PUD-****-3K(DUAL OUTPUT 3000V ISOLATION)



MECHANICAL DIMENSIONS & RECOMMENDED FOOTPRINT DETAILS

PACKAGE "A"

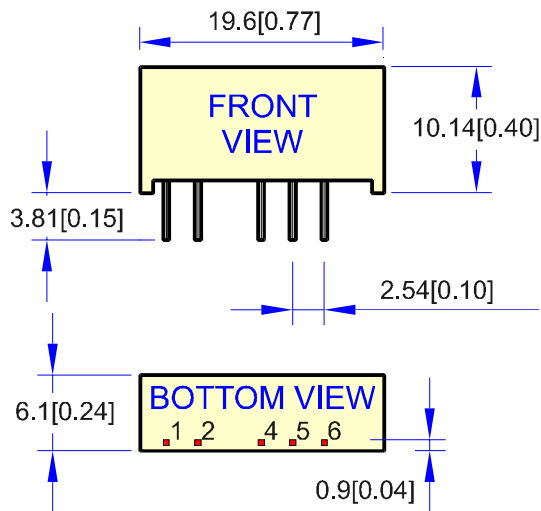

PIN	SINGLE	DUAL
1	+Vin	+Vin
2	-Vin	-Vin
4	-Vout	-Vout
5	NP	COMMON
6	+Vout	+Vout

All dimensions are in mm[inches]

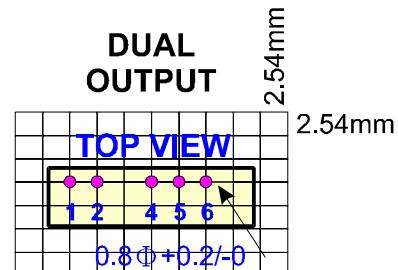
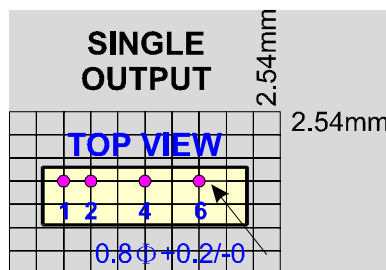

PACKAGE "B"

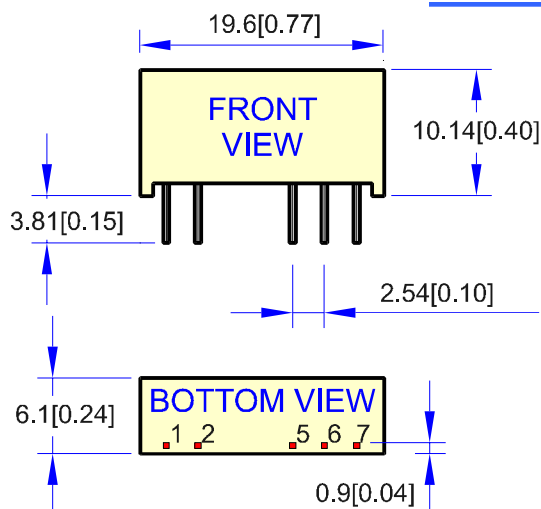

PIN	SINGLE	DUAL
1	+Vin	+Vin
2	-Vin	-Vin
5	-Vout	-Vout
6	NP	COMMON
7	+Vout	+Vout

All dimensions are in mm[inches]

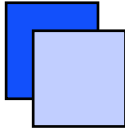

DC-DC Converter UNIT

PU Series (1W UNREGULATED DC-DC CONVERTER)

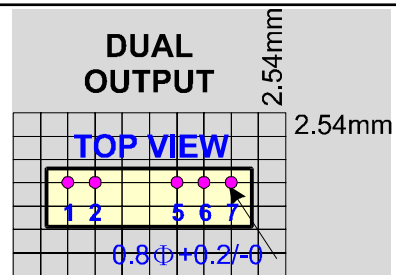
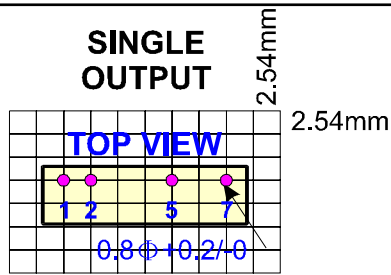

PACKAGE "C"

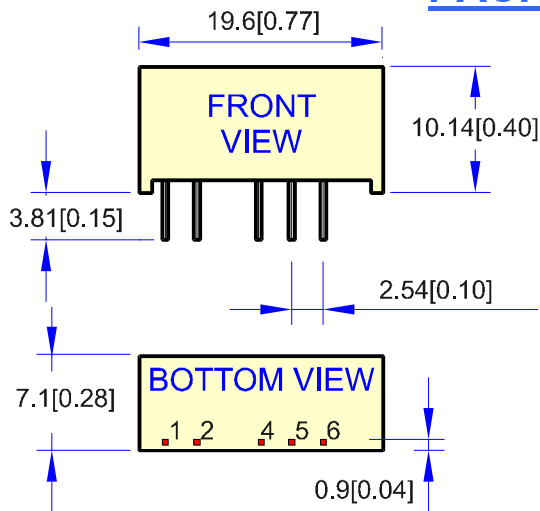

PIN	SINGLE	DUAL
1	+Vin	+Vin
2	-Vin	-Vin
4	-Vout	-Vout
5	NP	COMMON
6	+Vout	+Vout

All dimensions are in mm[inches]

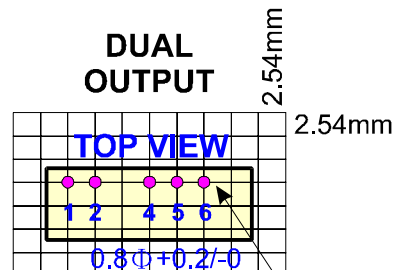
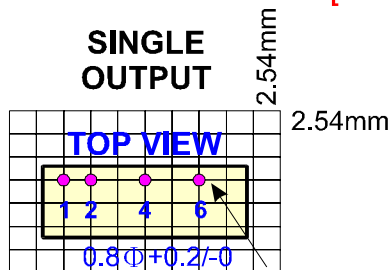

PACKAGE "D"

PIN	SINGLE	DUAL
1	+Vin	+Vin
2	-Vin	-Vin
5	-Vout	-Vout
6	NP	COMMON
7	+Vout	+Vout

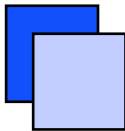

DC-DC Converter UNIT

PU Series (1W UNREGULATED DC-DC CONVERTER)

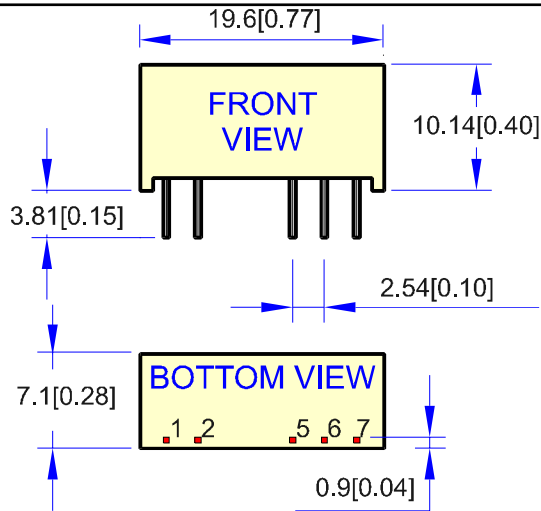

PIN	SINGLE	DUAL
1	+Vin	+Vin
2	-Vin	-Vin
5	-Vout	-Vout
6	NP	COMMON
7	+Vout	+Vout

All dimensions are in mm[inches]

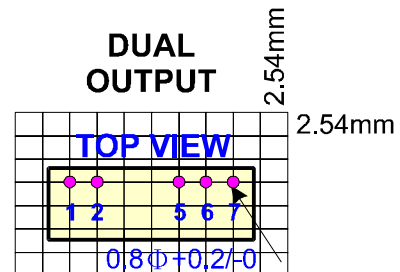
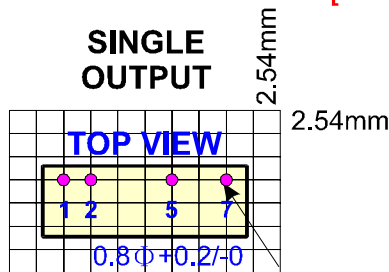

PACKAGE "E"

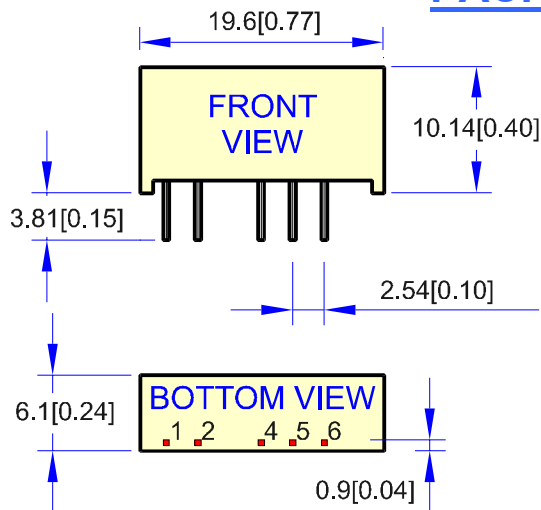

PIN	SINGLE	DUAL
1	+Vin	+Vin
2	-Vin	-Vin
4	NP	-Vout
5	-Vout	COMMON
6	+Vout	+Vout

All dimensions are in mm[inches]

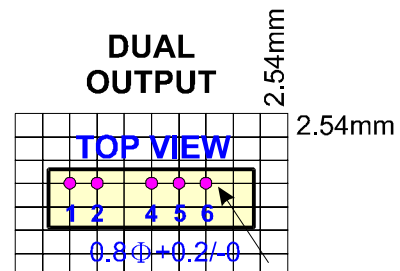
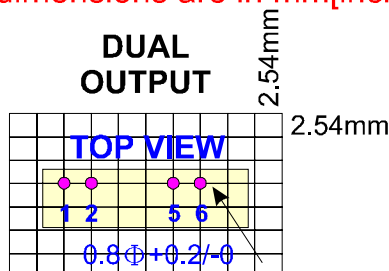

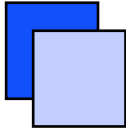

DC-DC Converter UNIT

PU Series (1W UNREGULATED DC-DC CONVERTER)

● SIMPLIFIED SCHEMATIC

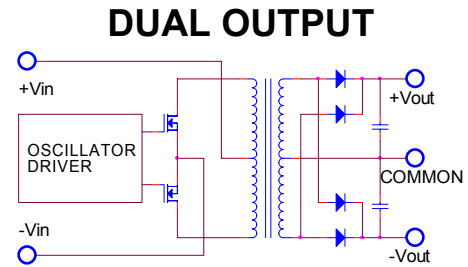
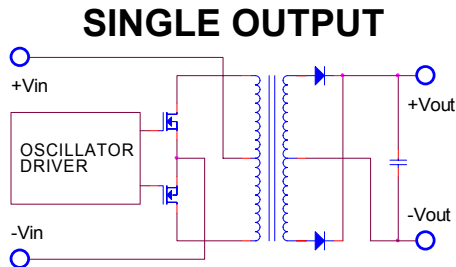

● TYPICAL APPLICATIONS

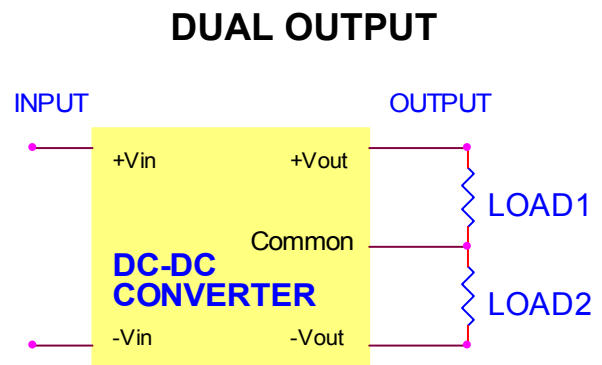
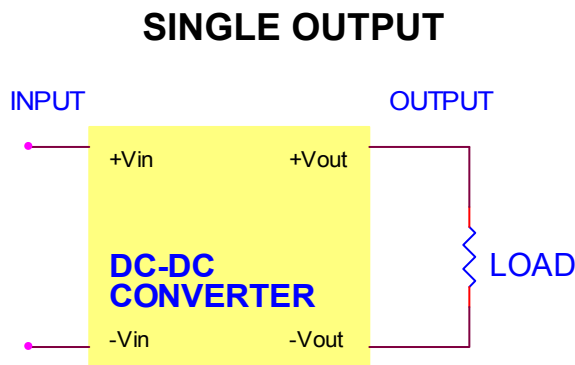

● TYPICAL PERFORMANCE CURVES

Specifications typical at $T_A=25^{\circ}\text{C}$, nominal input voltage, rated output current unless otherwise specified.

VOU_T VS LOAD(5V_{out} Models)

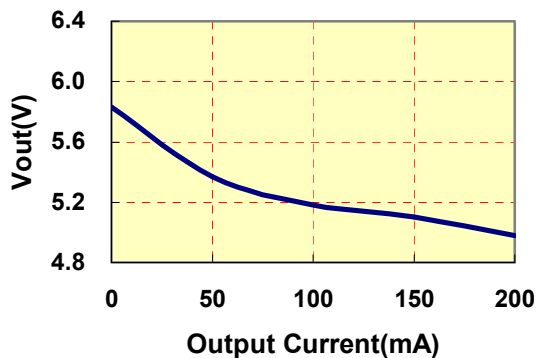

VOU_T VS LOAD(+/- 5V_{out} Models)

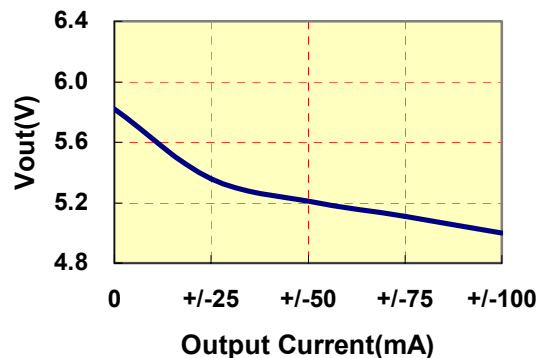

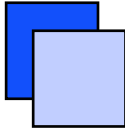

DC-DC Converter UNIT

PU Series (1W UNREGULATED DC-DC CONVERTER)

VOUT VS LOAD(12Vout Models)

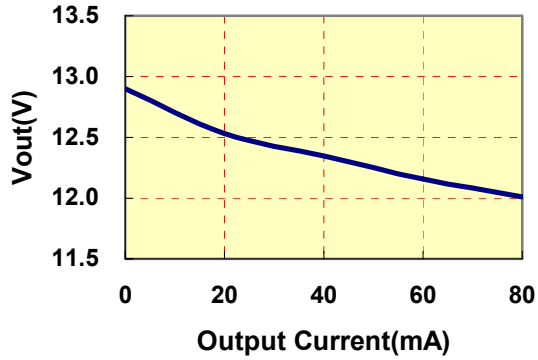

VOUT VS LOAD(+/- 12Vout Models)

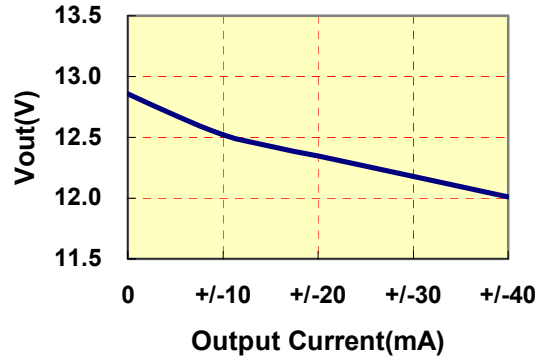

VOUT VS LOAD(15Vout Models)

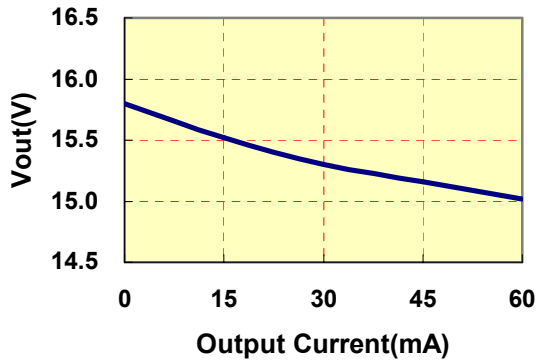

VOUT VS LOAD(+/- 15Vout Models)

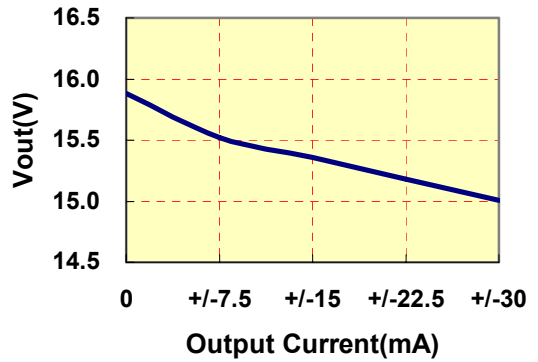

EFFICIENCY VS LOAD

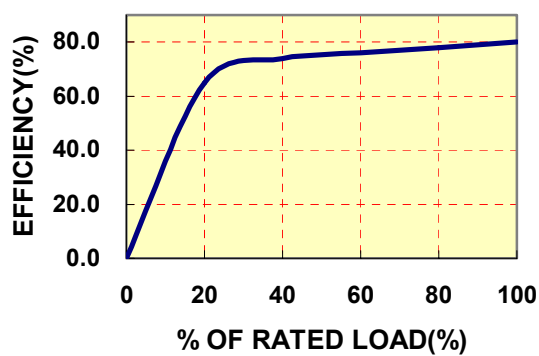

DERATING CURVE

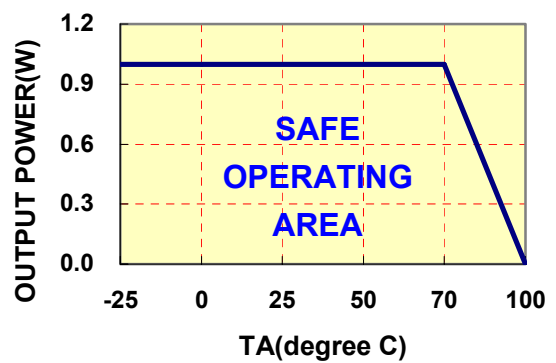

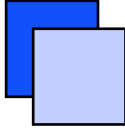

DC-DC Converter UNIT

PU Series (1W UNREGULATED DC-DC CONVERTER)

PU SERIES APPLICATION NOTES:

EXTERNAL CAPACITANCE REQUIREMENTS:

Output filtering is required for operation. A minimum of 10uF is needed. Output capacitance may be increased for additional filtering, not to exceed 220uF.

To meet the reflected ripple requirements of the converter, an input impedance of less than 0.5ohm from DC to 250KHz is required.

Negative Outputs:

A negative output voltage may be obtained by connecting the +OUT to circuit ground and connecting –OUT as the negative output.

FOR MORE INFORMATION CALL:

Power Systems – The Power Solution

74360 Ilsfeld-Auenstein (Germany) Dörnet 8

Tel: + 49 / 70 62 / 67 59 – 6

Fax: + 49 / 70 62 / 67 59 -80

E-mail: Info@Power-Systems.de

Home Page: www.Power-Systems.de
