

DC-DC Converter UNIT

TU Series (1W UNREGULATED DC-DC CONVERTER)

FEATURES

- 1000VDC ISOLATION
- EFFICIENCY UP TO 82%
- INTERNAL SMD TECHNOLOGY
- LOW COST
- NO HEATSINK REQUIRED
- UP TO 1W UNREGULATED OUTPUT POWER
- DUAL IN LINE PACKAGE
- 100% BURNED IN
- MTBF > 2,000,000 HOURS

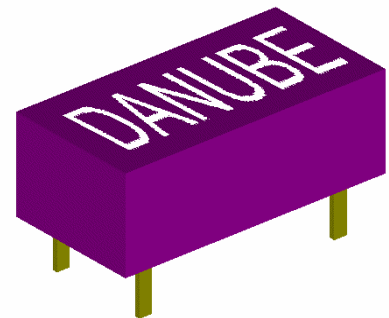

● OUTPUT SPECIFICATIONS

Voltage Setpoint Accuracy	+/-2% max
Temperature Coefficient	+/-0.03%/°C
Ripple & Noise (20MHz BW)	100mVp-p max
Line Regulation ¹	+/-1.2% max
Load Regulation ²	+/-8% max
Short Circuit Protection	Momentary

● ENVIRONMENTAL SPECIFICATIONS

Operating Temperature	-25°C to +71°C
Storage Temperature	-55°C to +125°C
Cooling	Free-Air Convection

● INPUT SPECIFICATIONS

Input Voltage Range	+/-10% max
Input Filter	Capacitor Type

● GENERAL SPECIFICATIONS

Efficiency	70%-82%
Isolation Voltage ³	1000 VDC min
Isolation Resistance	10 ⁹ ohms min
Switching Frequency	100 KHz min
Isolation Capacitance	80pF max
MTBF	2,000,000 Hours
Weight	2.2g Typ
Case Material	Non-Conductive Plastic
Case Size	20.3mm*10.2mm*7.1mm

ALL SPECIFICATIONS TYPICAL AT NOMINAL LINE, FULL LOAD , AND 25 °C UNLESS OTHERWISE NOTED.

¹ Line Regulation is for a 1.0% change in input Voltage.

² Load Regulation is for output load current change from 20% to 100%.

³ For 60 seconds

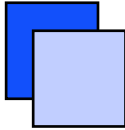

DC-DC Converter UNIT

TU Series (1W UNREGULATED DC-DC CONVERTER)

● SELECTION GUIDE 1W OUTPUT

MODEL NUMBER	INPUT VOLTAGE (VDC)	OUTPUT VOLTAGE (VDC)	OUTPUT CURRENT (mA)	INPUT CURRENT(mA)		EFF (%)	ISOLATION (VDC)
				FULL LOAD	NO LOAD		
				TUS-0505	5		
TUS-0512	5	12	84	253	26	79	1000
TUS-0515	5	15	67	253	28	79	1000
TUD-0505	5	+/-5	+/-100	274	26	73	1000
TUD-0512	5	+/-12	+/-42	253	26	79	1000
TUD-0515	5	+/-15	+/-34	253	28	79	1000
TUS-1205	12	5	200	112	11	74	1000
TUS-1212	12	12	84	102	11	82	1000
TUS-1215	12	15	67	102	12	82	1000
TUD-1205	12	+/-5	+/-100	112	11	74	1000
TUD-1212	12	+/-12	+/-42	102	11	82	1000
TUD-1215	12	+/-15	+/-34	102	12	82	1000
TUS-2405	24	5	200	57	8	73	1000
TUS-2412	24	12	84	54	8	77	1000
TUS-2415	24	15	67	52	7	80	1000
TUD-2405	24	+/-5	+/-100	57	8	73	1000
TUD-2412	24	+/-12	+/-42	54	8	77	1000
TUD-2415	24	+/-15	+/-34	52	7	80	1000

Note: Other input to output voltages may be available. Please contact factory.

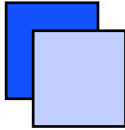

DC-DC Converter UNIT

TU Series (1W UNREGULATED DC-DC CONVERTER)

MECHANICAL DIMENSIONS & RECOMMENDED FOOTPRINT DETAILS

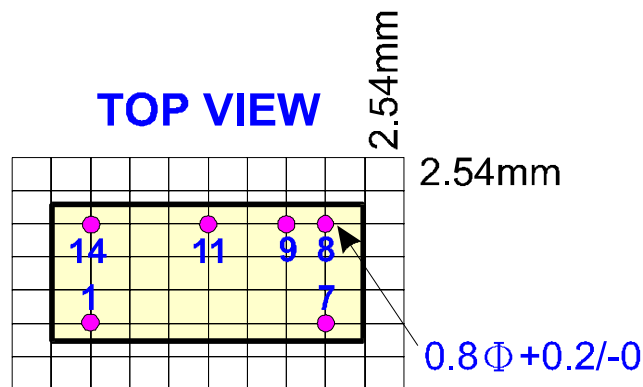
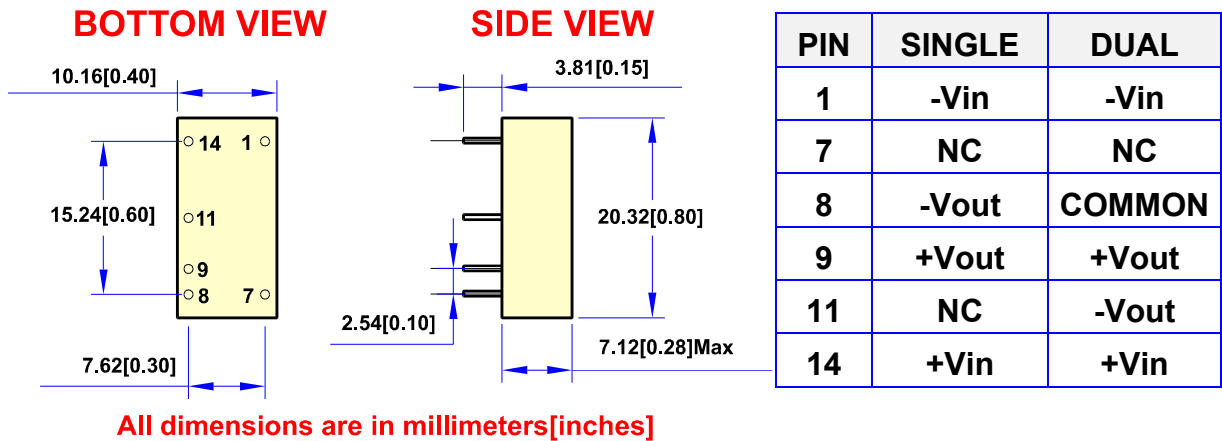

SIMPLIFIED SCHEMATIC

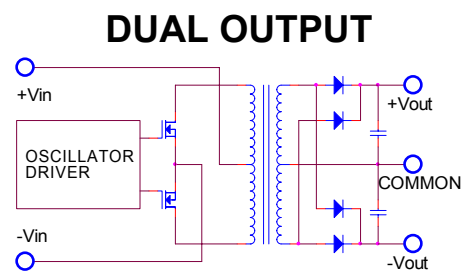
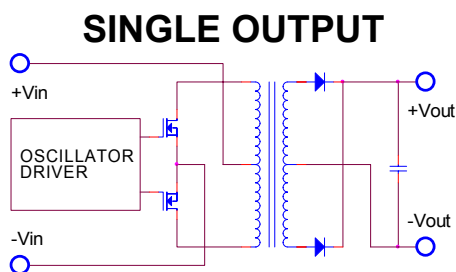

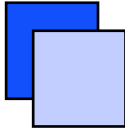

● TYPICAL APPLICATIONS

SINGLE OUTPUT

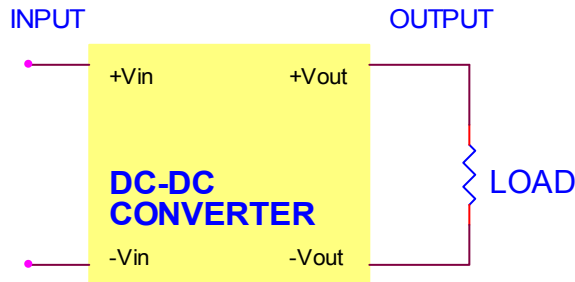

DUAL OUTPUT

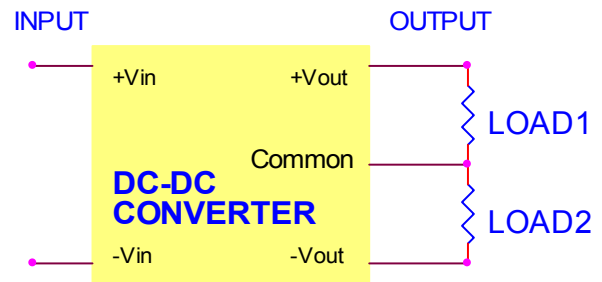

● TYPICAL PERFORMANCE CUREVES

Specifications typical at TA=25°C, nominal input voltage , rated output current unless otherwise specified.

VOU VS LOAD(5Vout Models)

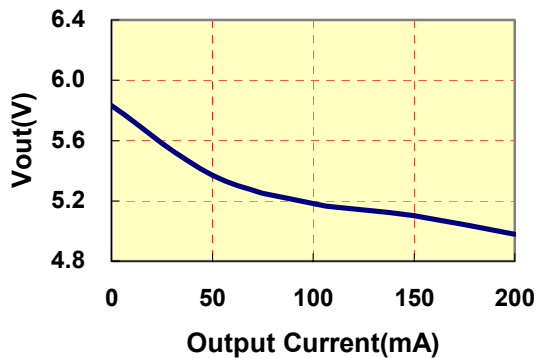

VOU VS LOAD(+/- 5Vout Models)

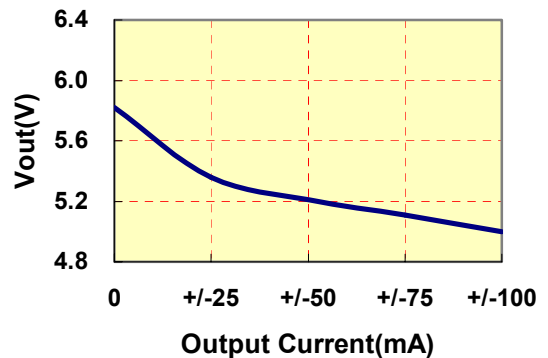

VOU VS LOAD(12Vout Models)

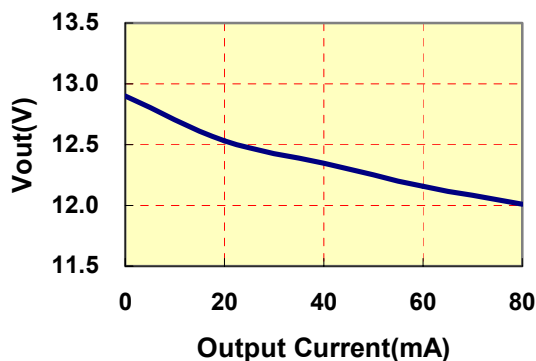

VOU VS LOAD(+/- 12Vout Models)

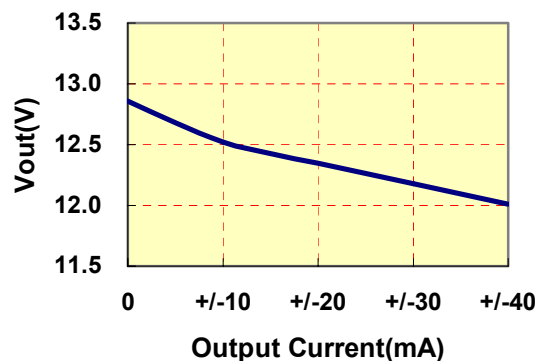

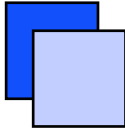

DC-DC Converter UNIT

TU Series (1W UNREGULATED DC-DC CONVERTER)

VOUT VS LOAD(15Vout Models)

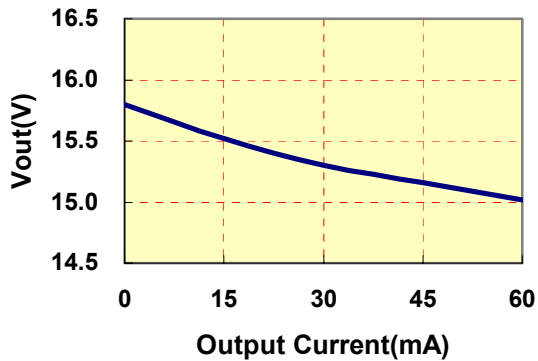

VOUT VS LOAD(+/- 15Vout Models)

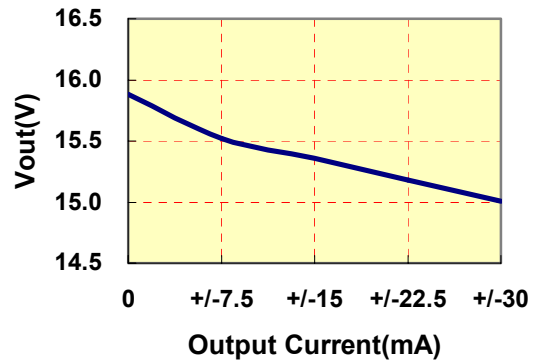

EFFICIENCY VS LOAD

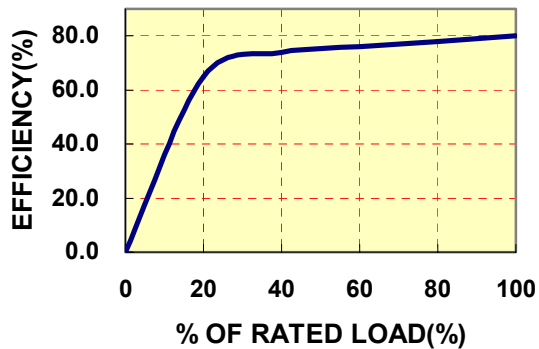

DERATING CURVE

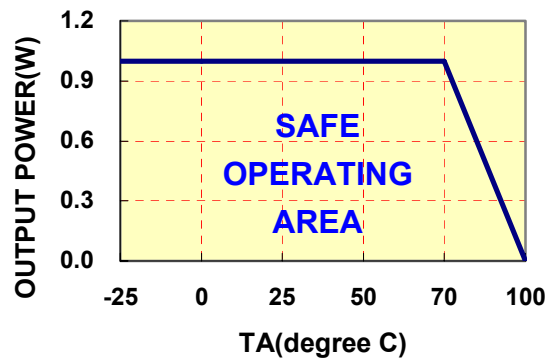

TU SERIES APPLICATION NOTES:

EXTERNAL CAPACITANCE REQUIREMENTS:

Output filtering is required for operation. A minimum of 10uF is needed. Output capacitance may be increased for additional filtering, not to exceed 220uF.

To meet the reflected ripple requirements of the converter, an input impedance of less than 0.5 ohm from DC to 250KHz is required.

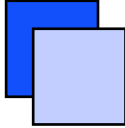

DC-DC Converter UNIT

TU Series (1W UNREGULATED DC-DC CONVERTER)

Negative Outputs:

A negative output voltage may be obtained by connecting the +OUT to circuit ground and connecting –OUT as the negative output.

FOR MORE INFORMATION CALL:

Power Systems – The Power Solution

74360 Ilsfeld-Auenstein (Germany) Dörnet 8

Tel: + 49 / 70 62 / 67 59 – 6

Fax: + 49 / 70 62 / 67 59 -80

E-mail: Info@Power-Systems.de

Home Page: www.Power-Systems.de
