



FEATURES:

- Wide 2:1 Input Range
- 24 Pin DIP Package
- High Efficiency up to 82%
- Metal Package
- Operating Temperature -40°C to +85°C
- Input / Output Isolation 1500 VDC
- Pin Compatible With Multiple Manufacturers
- Continuous Short Circuit Protection



Models
Single output

Model	Input Voltage (V)	Output Voltage (V)	Output Current Max (mA)	Capacitive Load, Max (µF)	Input Current Full No Load (mA)	Efficiency (%)
AM3T-0503S-RVZ	4.5-9	3.3	800	2200	650 70	73
AM3T-0505S-RVZ	4.5-9	5	600	2200	600 70	70
AM3T-0507S-RVZ	4.5-9	7.2	417	1000	417 72	72
AM3T-0509S-RVZ	4.5-9	9	333	470	333 72	72
AM3T-0512S-RVZ	4.5-9	12	250	470	250 74	74
AM3T-0515S-RVZ	4.5-9	15	200	470	200 74	74
AM3T-0518S-RVZ	4.5-9	18	167	220	167 74	74
AM3T-0524S-RVZ	4.5-9	24	125	220	125 70	70
AM3T-1203S-RVZ	9-18	3.3	800	2200	650 70	73
AM3T-1205S-RVZ	9-18	5	600	2200	600 70	76
AM3T-1207S-RVZ	9-18	7.2	417	1000	417 72	74
AM3T-1209S-RVZ	9-18	9	333	470	333 72	77
AM3T-1212S-RVZ	9-18	12	250	470	250 74	79
AM3T-1215S-RVZ	9-18	15	200	470	200 74	79
AM3T-1218S-RVZ	9-18	18	167	220	167 74	79
AM3T-1224S-RVZ	9-18	24	125	220	125 70	79
AM3T-2403S-RVZ	18-36	3.3	800	2200	650 70	70
AM3T-2405S-RVZ	18-36	5	600	2200	600 70	80
AM3T-2407S-RVZ	18-36	7.2	417	1000	417 72	77
AM3T-2409S-RVZ	18-36	9	333	470	333 72	80
AM3T-2412S-RVZ	18-36	12	250	470	250 74	82
AM3T-2415S-RVZ	18-36	15	200	470	200 74	82
AM3T-2418S-RVZ	18-36	18	167	220	167 74	79
AM3T-2424S-RVZ	18-36	24	125	220	125 70	80
AM3T-4803S-RVZ	36-72	3.3	800	2200	650 70	77
AM3T-4805S-RVZ	36-72	5	600	2200	600 70	77
AM3T-4807S-RVZ	36-72	7.2	417	1000	417 72	78
AM3T-4809S-RVZ	36-72	9	333	470	333 72	78
AM3T-4812S-RVZ	36-72	12	250	470	250 74	80
AM3T-4815S-RVZ	36-72	15	200	470	200 74	80
AM3T-4818S-RVZ	36-72	18	167	220	167 74	77
AM3T-4824S-RVZ	36-72	24	125	220	125 70	80

Models
Dual output

Model	Input Voltage (V)	Output Voltage (V)	Output Current Max (mA)	Capacitive Load, Max (µF)	Input Current Full No Load (mA)	Efficiency (%)
AM3T-0505D-RVZ	4.5-9	±5	±300	±1000	±300 69	69
AM3T-0507D-RVZ	4.5-9	±7.2	±208	±220	±208 67	67
AM3T-0509D-RVZ	4.5-9	±9	±167	±220	±167 70	70
AM3T-0512D-RVZ	4.5-9	±12	±125	±220	±125 72	72
AM3T-0515D-RVZ	4.5-9	±15	±100	±220	±100 74	74
AM3T-0518D-RVZ	4.5-9	±18	±83	±220	±83 74	74

Models

Dual output (continued)

Model	Input Voltage (V)	Output Voltage (V)	Output Current Max (mA)	Capacitive Load, Max (µF)	Input Current Full No Load (mA)	Efficiency (%)
AM3T-0524D-RVZ	4.5-9	±24	±63	±100	±63 70	70
AM3T-1205D-RVZ	9-18	±5	±300	±1000	±300 69	76
AM3T-1207D-RVZ	9-18	±7.2	±208	±220	±208 67	77
AM3T-1209D-RVZ	9-18	±9	±167	±220	±167 70	77
AM3T-1212D-RVZ	9-18	±12	±125	±220	±125 72	79
AM3T-1215D-RVZ	9-18	±15	±100	±220	±100 74	79
AM3T-1218D-RVZ	9-18	±18	±83	±220	±83 74	78
AM3T-1224D-RVZ	9-18	±24	±63	±100	±63 70	79
AM3T-2405D-RVZ	18-36	±5	±300	±1000	±300 69	80
AM3T-2407D-RVZ	18-36	±7.2	±208	±220	±208 67	78
AM3T-2409D-RVZ	18-36	±9	±167	±220	±167 70	80
AM3T-2412D-RVZ	18-36	±12	±125	±220	±125 72	82
AM3T-2415D-RVZ	18-36	±15	±100	±220	±100 74	82
AM3T-2418D-RVZ	18-36	±18	±83	±220	±83 74	80
AM3T-2424D-RVZ	18-36	±24	±63	±100	±63 70	80
AM3T-4805D-RVZ	36-72	±5	±300	±1000	±300 69	78
AM3T-4807D-RVZ	36-72	±7.2	±208	±220	±208 67	78
AM3T-4809D-RVZ	36-72	±9	±167	±220	±167 70	79
AM3T-4812D-RVZ	36-72	±12	±125	±220	±125 72	80
AM3T-4815D-RVZ	36-72	±15	±100	±220	±100 74	80
AM3T-4818D-RVZ	36-72	±18	±83	±220	±83 74	78
AM3T-4824D-RVZ	36-72	±24	±63	±100	±63 70	80

Input Specifications

Parameters	Nominal	Typical	Maximum	Units
Voltage range	5	4.5-9		VDC
	12	9-18		
	24	18-36		
	48	36-72		
Filter	π (Pi) Network			
Start-up time		20		ms
Absolute Maximum Rating	5 Vin	-0.7-15		VDC
	12 Vin	-0.7-24		
	24 Vin	-0.7-40		
	48 Vin	-0.7-80		
Peak Input Voltage time		15		ms

Isolation Specifications

Parameters	Conditions	Typical	Rated	Units
Tested I/O voltage	60 sec		1500	VDC
Resistance		> 1000		MOhm
Capacitance		60		pF

Output Specifications

Parameters	Conditions	Typical	Maximum	Units
Voltage accuracy		±1		%
Voltage balance	Balanced Load	±1		%
Short circuit protection	Continuous			
Short circuit restart	Auto Recovery			
Line voltage regulation		±0.5		%
Load voltage regulation		±0.5		%
Temperature coefficient		±0.02		%/°C
Ripple & Noise*	At 20MHz Bandwidth	60		mV p-p

* In order to achieve ripple and noise specification, a 100µF capacitor is required to be connected to the output of the converter

General Specifications

Parameters	Conditions	Typical	Maximum	Units
Switching frequency	100% load	100-400		KHz
Operating temperature	Full Load (see derating chart)		-40 to +85	°C
Storage temperature			-40 to +125	°C
Max Case temperature			100	°C
Cooling	Free air convection			
Humidity			95	%
Case material	Nickel coated copper			
Weight		12.16		g
Dimensions (L x W x H)	Tolerance ±0.5 mm or ±0.02 inches	1.25 x 0.8 x 0.4 inches	31.75 x 20.32 x 10.16 mm	
MTBF	>1,000,000 hrs (MIL-HDBK -217F, Ground Benign, t=+25°C)			

Safety Specifications

Parameters	
Agency approvals	CE
Standards	Designed to meet IEC 60950-1

NOTE: All specifications in this datasheet are measured at an ambient temperature of 25°C, humidity<75%, nominal input voltage and at rated output load unless otherwise specified.

Pin Out Specifications

Pin	1500 VDC	
	Single	Dual
2	-V Input	-V Input
3	-V Input	-V Input
9	No pin	Common
11	N.C.	-V Output
14	+V Output	+V Output
16	-V Output	Common
22	+V Input	+V Input
23	+V Input	+V Input

Dimensions

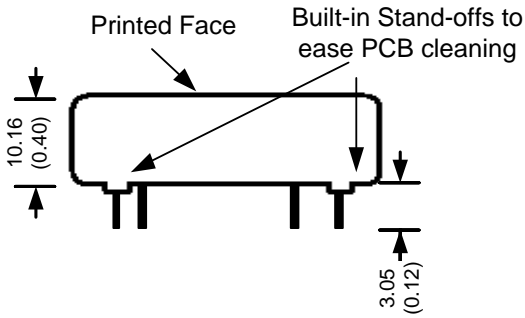
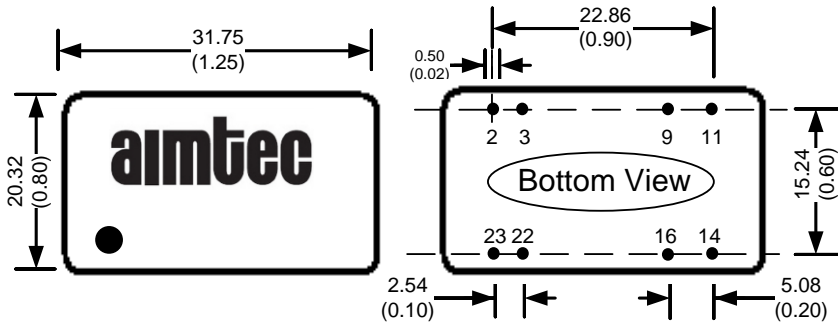

Derating

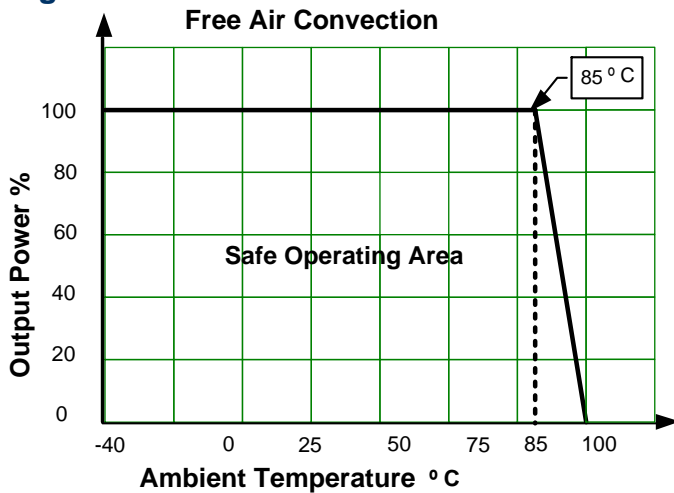

Typical Efficiency Chart Examples

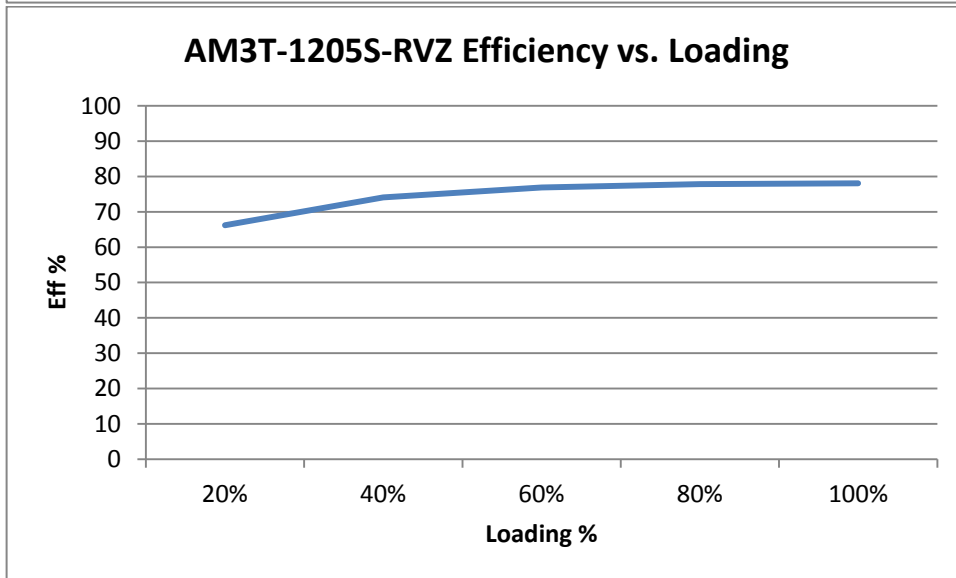
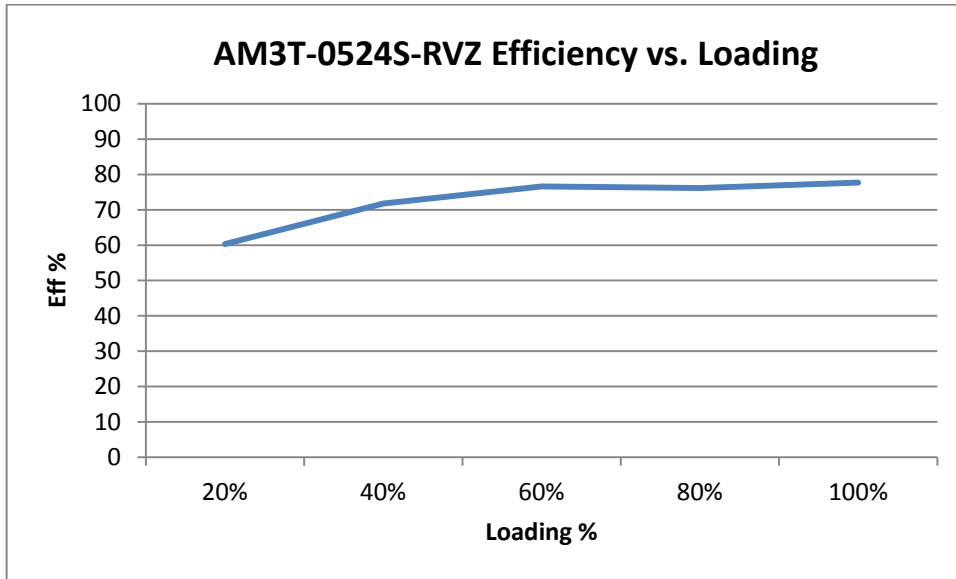

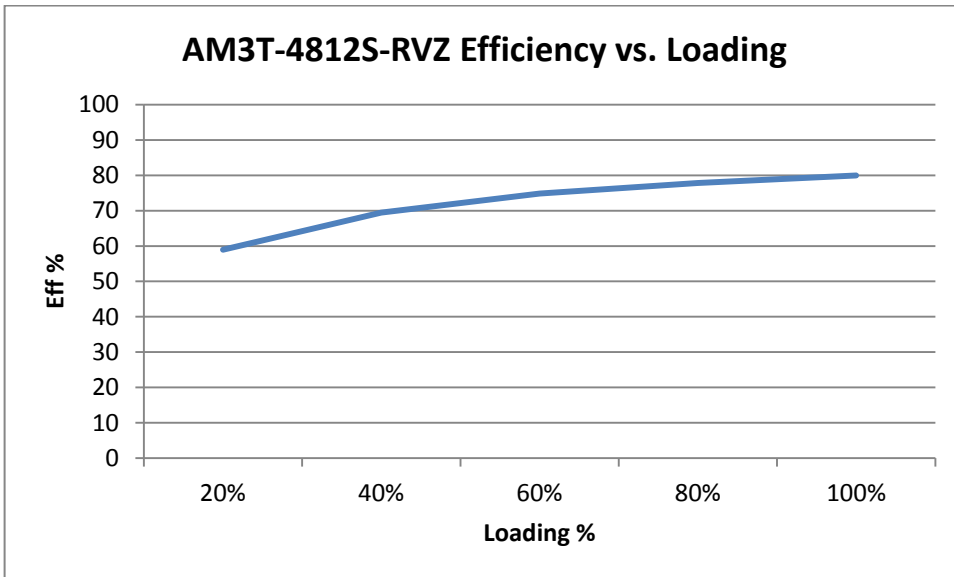
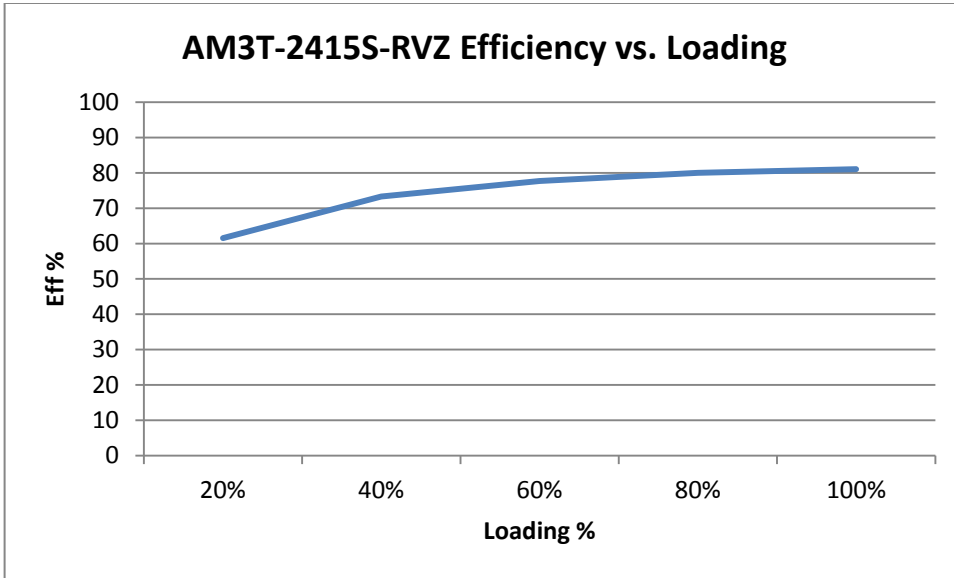

NOTE: **1.** Datasheets are updated as needed and as such, specifications are subject to change without notice. Once printed or downloaded, datasheets are no longer controlled by Aimtec; refer to www.aimtec.com for the most current product specifications. **2.** Product labels shown, including safety agency certifications on labels, may vary based on the date manufactured. **3.** Mechanical drawings and specifications are for reference only. **4.** All specifications are measured at an ambient temperature of 25°C, humidity<75%, nominal input voltage and at rated output load unless otherwise specified. **5.** Aimtec may not have conducted destructive testing or chemical analysis on all internal components and chemicals at the time of publishing this document. CAS numbers and other limited information are considered proprietary and may not be available for release. **6.** This product is not designed for use in critical life support systems, equipment used in hazardous environments, nuclear control systems or other such applications which necessitate specific safety and regulatory standards other the ones listed in this datasheet. **7.** Warranty is in accordance with Aimtec's standard Terms of Sale available at www.aimtec.com.